

Durable Industrial Connectors

Contents

Introduction	200
Archer Kontrol: 1.27mm pitch Connectors	
Specifications	202
Mating Profiles	203
Female PCB Connectors	204
Female Cable Assemblies	206
Male PCB Connectors	207
Circular Connectors: MIL-DTL-5015 equivalent	
Introduction	213
Specifications	215
Cable Connectors	216
Panel Connectors	217
Accessories	218

Rectangular Connectors Introduction

Durable, rugged double-row high performance connection systems, designed to meet the tough challenges of industrial application environments and cost requirements.

These rectangular connectors are supplied in a choice of contact pitches - 1.27mm pitch for board-to-board & cable-to-board (Archer Kontrol), ~~or 2mm pitch for cable-to-board (M225 Series).~~ Shrouded and polarized connector bodies help withstand lateral and twisting forces, and protect unmated connector contacts.

- ❖ Increased operating temperature range: -55°C to +125°C
- ❖ Stocked in depth across Harwin's authorized distributor network

Durable Industrial Rectangular Connectors provide an excellent connection system for a variety of demanding industrial environments.

- ❖ Industrial: factory and mobile machinery, control panels and sub-systems, drives, robotics and other automation
- ❖ Instrumentation: test equipment and portable hand-held devices
- ❖ Site Control: remote control devices, ground and machinery monitoring
- ❖ IOT installations, dataloggers, trackside monitoring equipment, vehicle control systems

Archer Kontrol

- ❖ Current rating of 1.2A per contact
- ❖ Vertical and Horizontal options in both male and female connectors - board-to-board connection for parallel/mezzanine with variable stacking heights, motherboard to daughterboard, or coplanar/edge-to-edge PCB layouts
- ❖ Ready-made IDC cable assemblies, double ended with latching female connectors

~~M225 Connectors~~

- ❖ Current rating of 3A per signal contact (all electrically loaded; 3.3A per individual contact)
- ❖ Cable-to-board connection, with vertical PCB mounted male
- ❖ Female crimp contacts on continuous strip for automated crimping
- ❖ Simple locking mechanism - push fixing pin fully home to expand and lock the rubber collar into the male connector



Rectangular Connectors Product Features

Designed for Automated Manufacturing

All board-to-board (Archer Kontrol) connectors are supplied in tape and reel, ~~all female cable contacts (M225 Series) are available on continuous feed strip.~~



Rugged construction and polarization

Vibration resistant to 20G (Archer Kontrol) ~~and 10G (M225 Series)~~, suitable for operational temperatures from -55°C to +125°C, with significant polarization features to prevent mis-mating in daily use.



Archer Kontrol - High speed data transmission

Data transmission rates of 3Gbit/s if the system is suitably designed, by analysis of insertion loss and near-end crosstalk (NEXT).



Archer Kontrol - IDC connection for cable-to-board

Ready-made cable assemblies constructed with 30AWG ribbon cable, off-the-shelf for immediate availability. Latching features for added strain relief.



Archer Kontrol - Wide choice of stacking heights

Variable stack heights for parallel / mezzanine PCB placement, from 8.00mm to 20.00mm. Right angle mother/daughterboard and co-planar orientations also possible.



Archer Kontrol - PCB location and strain relief

Both vertical and horizontal connectors feature location pegs to assist with SMT board placement, and additional strain relief is provided with SMT hold-down tabs.

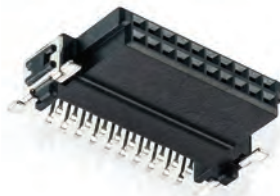

~~M225 Series - Fast and easy locking system~~

~~Simple locking mechanism – push fixing pin fully home to expand and lock the rubber collar into the male connector.~~

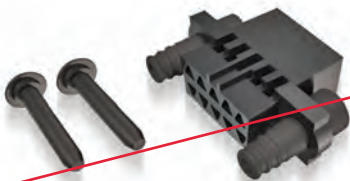

~~M225 Series - 3 points of contact~~

~~Improved signal integrity assurance with female Beryllium Copper contacts, giving vibration and shock resistance.~~



Archer Kontrol Specification

Materials

Housings:	High Temperature Plastic UL94V-0
Cable Cover:	Nylon UL94V-0
Contacts:	Phosphor Bronze
Retaining Strap:	Brass
Cable Latch Spring:	Stainless Steel
Cable Insulation:	PVC
Finish	
Contacts:	Gold on contact area, Tin on tails
Retaining Strap:	Tin

Electrical

Current	
PCB Connectors:	1.2A max per contact
Cable Assemblies:	0.5A max per contact
Working voltage:	100V AC
Voltage proof:	500V AC for 1 minute
Contact resistance	
Initial:	25mΩ max
After Conditioning:	35mΩ max
Insulation resistance	
PCB Connectors:	10GΩ min
Cable Assemblies:	1GΩ min
Data Rate:	Up to 3GBits/s

Mechanical

Durability:	500 operations
Insertion force (max):	0.8N per contact
Withdrawal force (min):	0.2N per contact

Environmental

Operating temperature	
PCB Connectors:	-55°C to +125°C
Cable Assemblies:	-20°C to +105°C
Vibration sensitivity:	10Hz to 2000Hz, 1.52mm, 196m/s ² (20G), duration 12h
Solderability:	245°C for 5 seconds
Soldering heat resistance:	260°C for 10 seconds

Pin Numbering

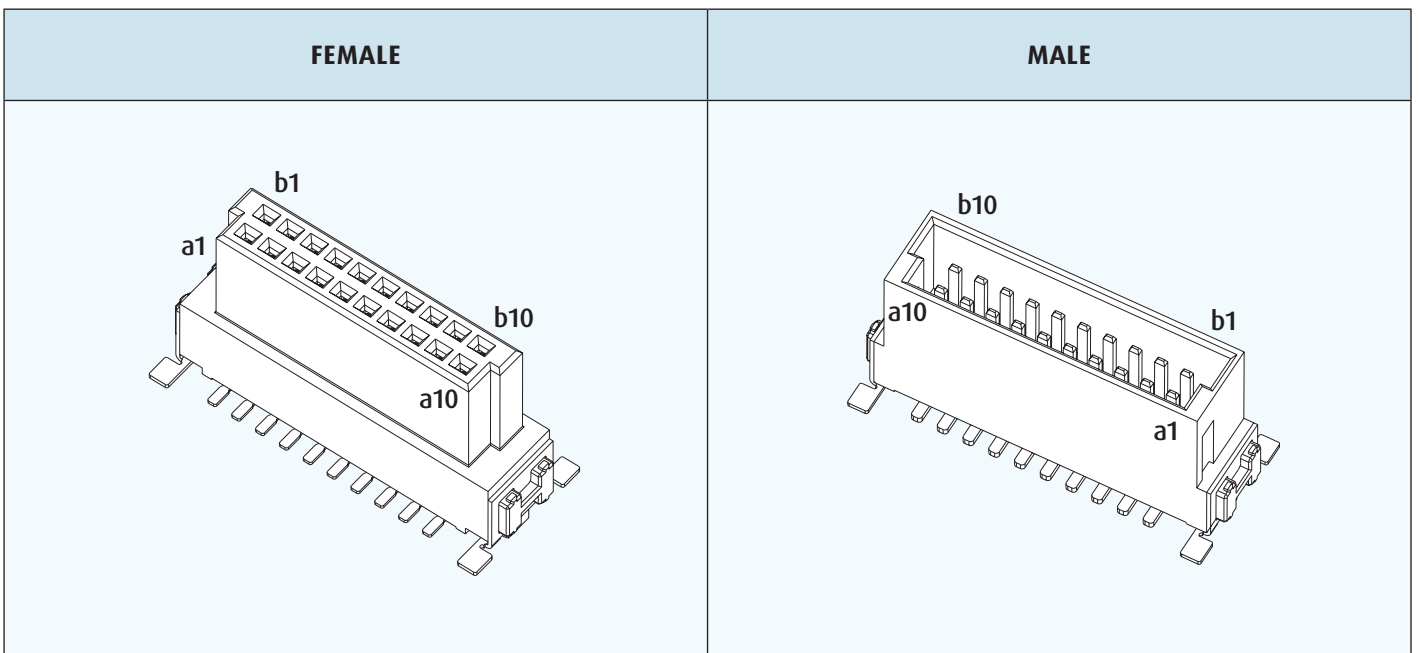

All dimensions in mm.

Archer Kontrol Mating Profiles

- ❖ Mating heights shown in fully mated condition.
- ❖ Board-to-Board products can be used up to 1.5mm separated and still perform to the same specifications.

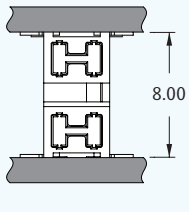
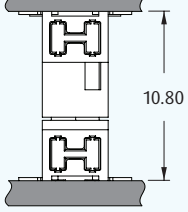
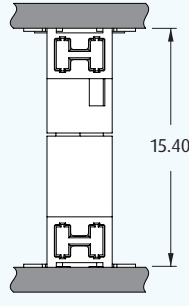
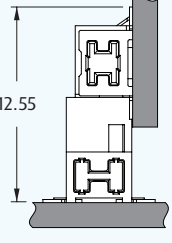
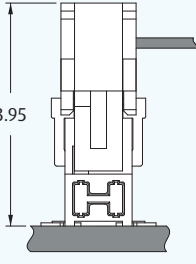
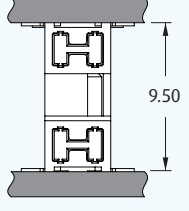
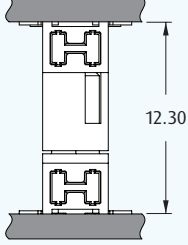
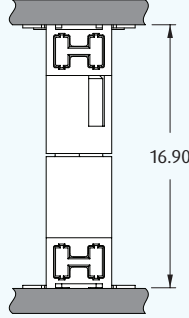
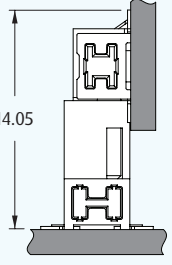
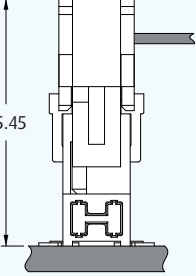
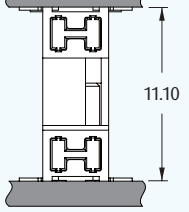
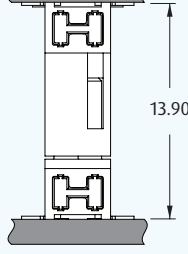
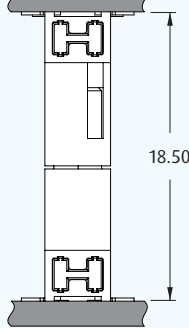
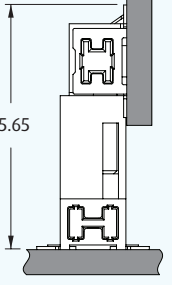
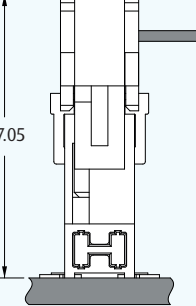
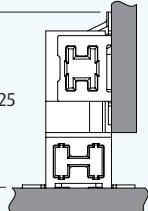
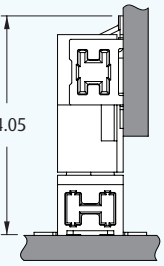
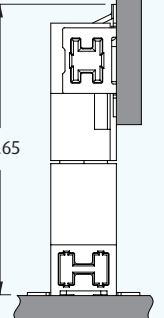
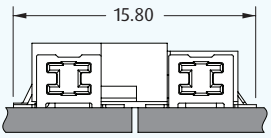
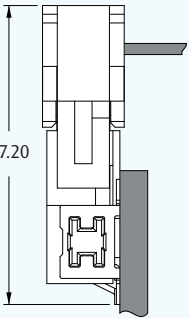
		FEMALE				
		VERTICAL SMT			HORIZONTAL SMT	CABLE
		6.25mm HEIGHT	9.05mm HEIGHT	13.65mm HEIGHT		
MALE	VERTICAL SMT	 <p>6.75mm HEIGHT</p> <p>8.00</p>	 <p>10.80</p>	 <p>15.40</p>	 <p>12.55</p>	 <p>13.95</p>
	 <p>8.25mm HEIGHT</p> <p>9.50</p>	 <p>12.30</p>	 <p>16.90</p>	 <p>14.05</p>	 <p>15.45</p>	
	 <p>9.85mm HEIGHT</p> <p>11.10</p>	 <p>13.90</p>	 <p>18.50</p>	 <p>15.65</p>	 <p>17.05</p>	
	 <p>11.25</p>	 <p>14.05</p>	 <p>18.65</p>	 <p>15.80</p>	 <p>17.20</p>	

All dimensions in mm.

Archer Kontrol Connectors

Female Vertical Surface Mount

- ❖ Suitable for parallel board-to-board (mezzanine stacking) or motherboard-to-daughterboard configurations.
- ❖ Choice of three height options.
- ❖ Polarized and shrouded housing design.
- ❖ Location pegs and tape & reel packaging for automated assembly processes.

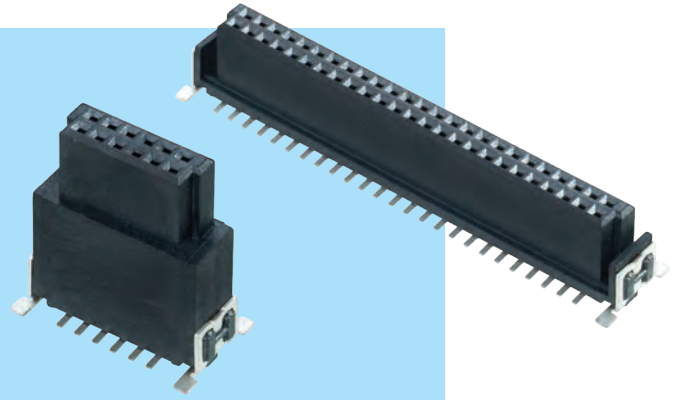

VERTICAL

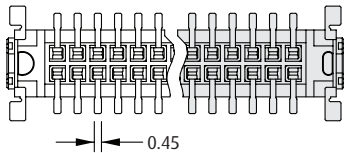
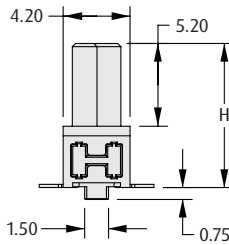
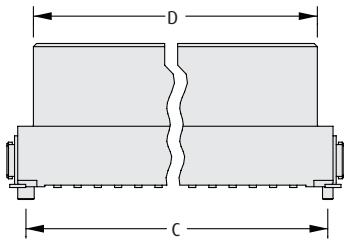
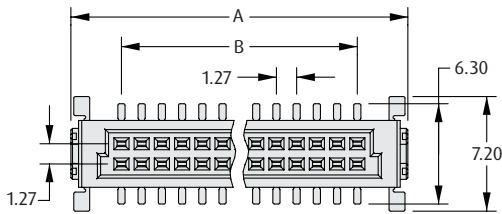

CALCULATION

A	$B + 6.35$
B	$0.635 \times (\text{Total No. of contacts} - 2)$
C	$B + 4.42$
D	$B + 3.02$

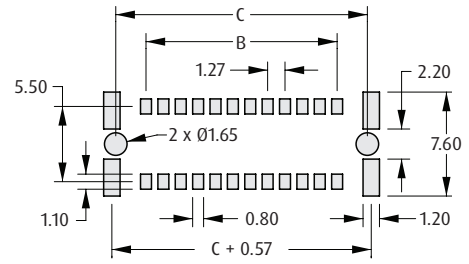

Recommended PC Board Pattern

HOW TO ORDER

M55 - 60 X XX 42 R

SERIES CODE

CONNECTOR HEIGHT

0	H = 6.25mm
1	H = 9.05mm
2	H = 13.65mm

PACKAGING

R Tape & Reeled

FINISH

42 Gold + Tin

TOTAL NO. OF CONTACTS

12, 16, 20, 26, 32, 40, 50, 68, 80

All dimensions in mm.

Archer Kontrol Connectors

Female Horizontal Surface Mount

- ❖ Suitable for coplanar (edge-to-edge) or motherboard-to-daughterboard configurations.
- ❖ Hold-down SMT retaining straps for additional retention to the board.
- ❖ Polarized and shrouded housing design.
- ❖ Location pegs and tape & reel packaging for automated assembly processes.

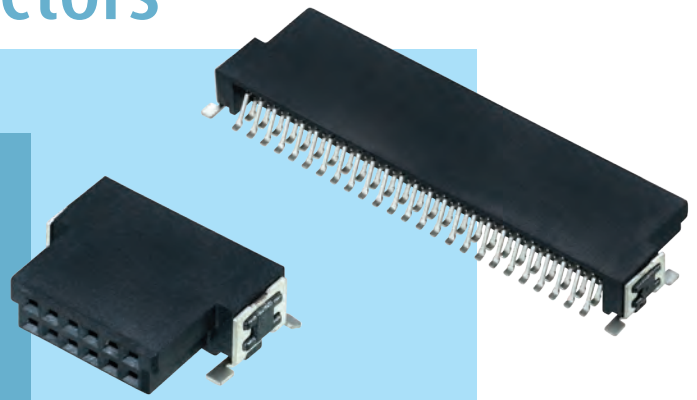

ARCHER CONTROL

HORIZONTAL

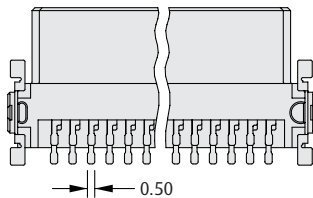
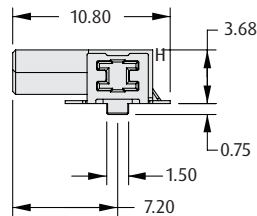
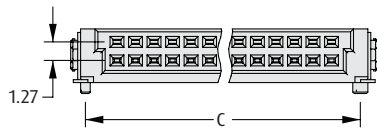
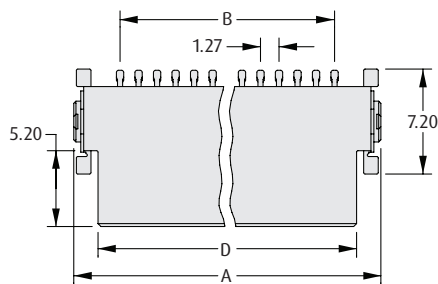

CALCULATION

A	$B + 6.35$
B	$0.635 \times (\text{Total No. of contacts} - 2)$
C	$B + 4.42$
D	$B + 3.02$

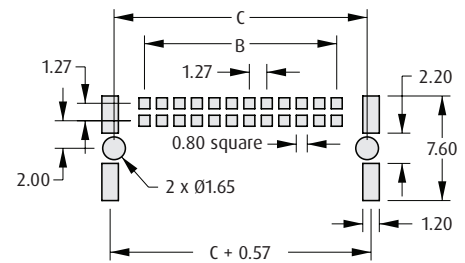

Recommended PC Board Pattern

HOW TO ORDER

M55 - 610 XX 42 R

SERIES CODE

TOTAL NO. OF CONTACTS

12, 16, 20, 26, 32, 40, 50, 68, 80

PACKAGING

R Tape & Reeled

FINISH

42 Gold + Tin

All dimensions in mm.

Archer Kontrol Connectors

Female Cable Assemblies

- ❖ Ready-made cable assemblies with female IDC connectors on both ends.
- ❖ Fitted with 30AWG ribbon cable to UL2678.
- ❖ Contact a1 is attached to a1, contact b1 attached to b1, etc.
- ❖ Compatible with all male Archer Kontrol connectors.
- ❖ For additional cable lengths, please consult our Experts at www.harwin.com/contact.

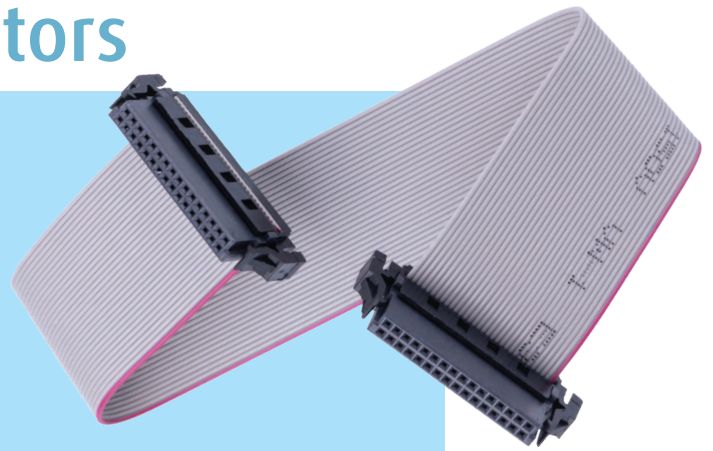

FEMALE-FEMALE DOUBLE ENDED

CALCULATION

A	$B + 9.65$
B	$0.635 \times (\text{Total No. of contacts} - 2)$
D	$B + 3$

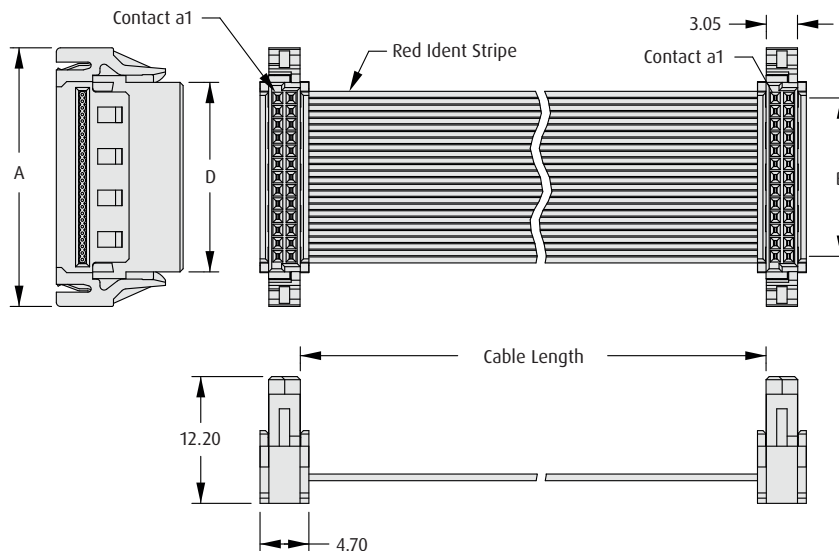

HOW TO ORDER

M55 - 800 XX 42 - XXXX - A

SERIES CODE

TOTAL NO. OF CONTACTS

12, 16, 20, 26, 32, 40, 50, 68, 80

CABLE LENGTH

0150 150mm

0300 300mm

FINISH

42 Gold + Tin

All dimensions in mm.

Archer Kontrol Connectors

Male Vertical Surface Mount

- ❖ Suitable for parallel board-to-board (mezzanine stacking) or motherboard-to-daughterboard configurations.
- ❖ Choice of three height options.
- ❖ Polarized and shrouded housing design.
- ❖ Location pegs and tape & reel packaging for automated assembly processes.

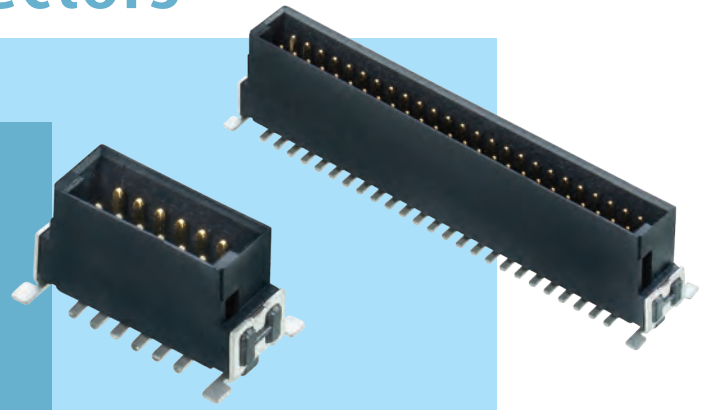

ARCHER CONTROL

VERTICAL

CALCULATION

A	$B + 6.35$
B	$0.635 \times (\text{Total No. of contacts} - 2)$
C	$B + 4.42$
D	$B + 4.02$

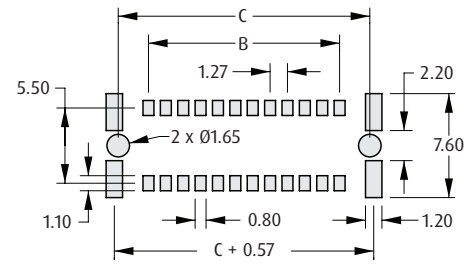
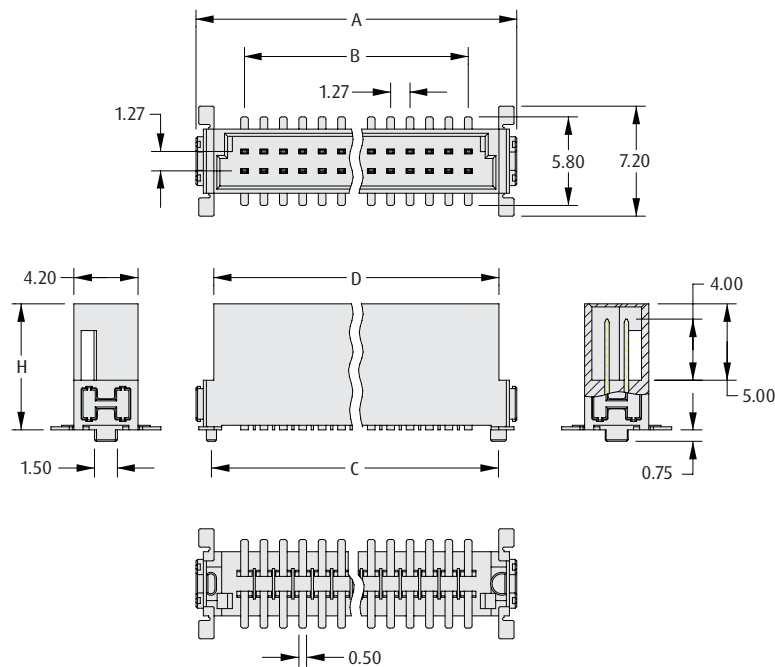

Recommended PC Board Pattern

HOW TO ORDER

M55 - 70 X XX 42 R

SERIES CODE

CONNECTOR HEIGHT

0	H = 6.75mm
1	H = 8.25mm
2	H = 9.85mm

PACKAGING

R Tape & Reeled

FINISH

42 Gold + Tin

TOTAL NO. OF CONTACTS

12, 16, 20, 26, 32, 40, 50, 68, 80

All dimensions in mm.

Archer Kontrol Connectors

Male Horizontal Surface Mount

- ❖ Suitable for coplanar (edge-to-edge) or motherboard-to-daughterboard configurations.
- ❖ Hold-down SMT retaining straps for additional retention to the board.
- ❖ Polarized and shrouded housing design.
- ❖ Location pegs and tape & reel packaging for automated assembly processes.

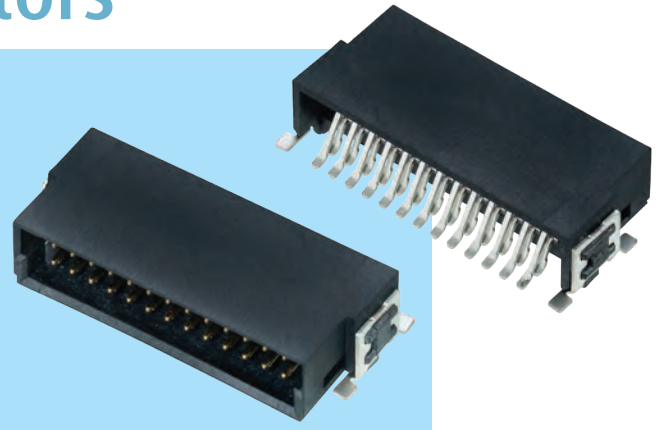

HORIZONTAL

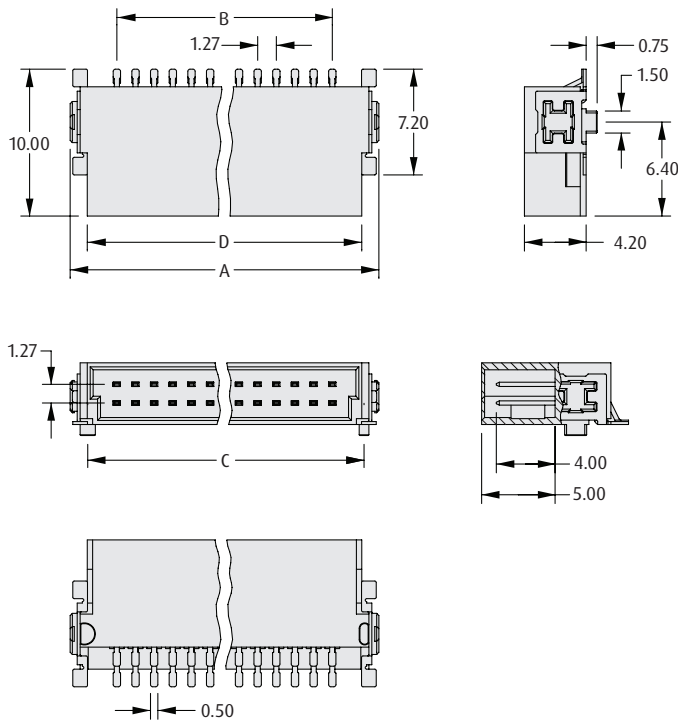

CALCULATION

A	$B + 6.35$
B	$0.635 \times (\text{Total No. of contacts} - 2)$
C	$B + 4.42$
D	$B + 4.02$

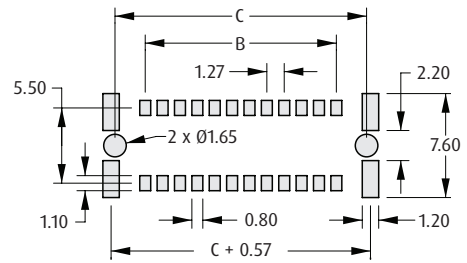

Recommended PC Board Pattern

HOW TO ORDER

M55 - 710 XX 42 R

SERIES CODE

PACKAGING

R Tape & Reeled

FINISH

42 Gold + Tin

TOTAL NO. OF CONTACTS

12, 16, 20, 26, 32, 40, 50, 68, 80

All dimensions in mm.

Circular Connectors Introduction

A range of high reliability, rugged, RoHS-compliant Circular Connectors to meet the high standards of MIL-DTL-5015, priced to be cost-effective for commercial and industrial applications.

These connectors are designed for use in harsh environments. The high specification connectors are Cadmium-free and Hexavalent-Chromium-free to satisfy the requirements of RoHS (unlike the military standard version of MIL-DTL-5015). The connector range features free plugs, panel mount and cable connector orientations, in a number of popular shell and layout types. Pin and socket contacts can be selected in either side of a mating pair.

- ❖ Increased operating temperature range: -55°C to +125°C
- ❖ Stocked in depth across Harwin's authorized distributor network

Features

- ❖ Intermateable with MIL-DTL-5015
- ❖ Low cost, highly durable & rugged connector system
- ❖ Solder termination
- ❖ Full environmental sealing with the use of backshells and sealing gaskets, exceeds IP67
- ❖ Threaded and polarized coupling
- ❖ Zinc Cobalt alloy black shells, for RoHS compliance
- ❖ COTS applications where MIL spec is not mandatory



All dimensions in mm.

Circular Connectors Product Features

RoHS compliant alternative

The military version of these connectors requires a Hexavalent Chromium mixture in the black coating - the Harwin alternative uses a different Zinc Cobalt alloy which is just as durable.



Fully compatible with MIL-DTL-5015

All other material, dimensional and performance specifications are met. Connectors are fully compatible with MIL-DTL-5015 connectors.



Watertight connection

Exceeds IP67 sealing requirements - when mated and fitted with all gaskets and rubber bushings, capable of water immersion of 1.8m for 48 hours.



Simple solder cable assembly

All contacts are terminated in a solder cup design, for attachment to 16 to 22AWG cables.



Strong, durable body and backshell

Connector bodies are manufactured from a strong aluminium alloy, coated with a black zinc cobalt alloy for additional durability.



Ideal for COTS substitution

Meeting all the requirements for the existing military product, substitution for this RoHS alternative gives potential product cost savings.



All dimensions in mm.

Circular Connectors Specification

Materials

Outer shell:	Aluminium Alloy base material, Zinc Cobalt Alloy, Black finish
Inner contacts:	Copper Alloy, Silver finish
Insulator, Grommet:	Synthetic Rubber

Electrical

Current:	13A
Working voltage	
10SL shell:	500V AC, 700V DC
12S shell:	500V AC, 700V DC
14S shell:	200V AC, 250V DC
Voltage proof	
10SL shell:	2,000V AC
12S shell:	2,000V AC
14S shell:	1,000V AC
Insulation resistance:	5,000MΩ min

Mechanical

Durability:	500 operations
-------------	----------------

Environmental

Operating temperature:	-55°C to +125°C
Vibration sensitivity:	10Hz to 500Hz, 98m/s ² (10G)
Shock severity:	490m/s ² (50G) for 11ms
Water resistance (sealing):	1.8m for 48 hours - exceeds IP67

Wire Detail

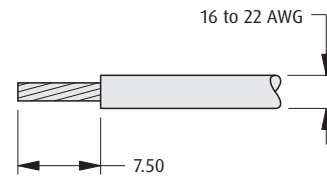

Pin Numbering & Spacing

Views are shown onto the mating face of each connector type.

	10SL SHELL		12S SHELL	14S SHELL	
	2 CONTACT (10SL-4)	3 CONTACT (10SL-3)	2 CONTACT (12S-3)	4 CONTACT (14S-2)	6 CONTACT (14S-6)
FEMALE					
MALE					

All dimensions in mm.

Circular Connectors

Cable Connector & Straight Plug

- Male & female circular connectors intermateable with MIL-DTL-5015.
- Rugged connector system for harsh environments.
- Exceeds IP67.
- Recommended wire strip length is 7.5mm.



CABLE CONNECTOR

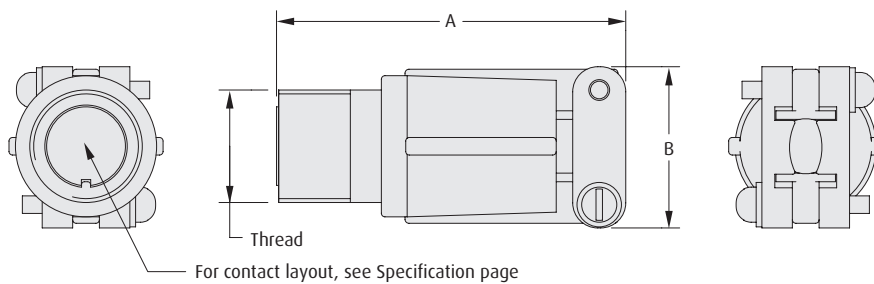

SHELL SIZE	THREAD	A max	B max
10SL-3	5/8-24UNEF	54.10	22.76
10SL-4	5/8-24UNEF	54.10	22.76
12S-3	3/4-20UNEF	54.10	22.76
14S-2	7/8-20UNEF	54.10	25.94
14S-6	7/8-20UNEF	54.10	25.94

- Connector Kit includes internal sealing grommet (not shown here).

STRAIGHT PLUG

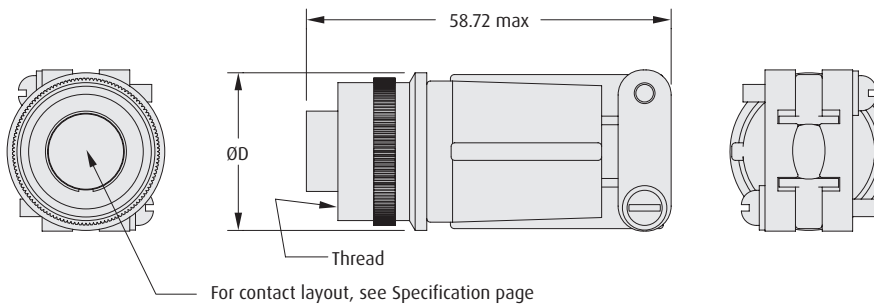

SHELL SIZE	THREAD	ØD
10SL-3	5/8-24UNEF	22.04
10SL-4	5/8-24UNEF	22.04
12S-3	3/4-20UNEF	25.40
14S-2	7/8-20UNEF	28.30
14S-6	7/8-20UNEF	28.30

- Connector Kit includes internal sealing grommet and rear rubber bushing (not shown here).

HOW TO ORDER

C90 - 310XX XXXX - X X

SERIES CODE

TYPE

3101F	Cable connector with backshell
3106F	Straight plug with backshell

CONTACT GENDER

P	Male
S	Female

SHELL SIZE

10SL-3	Thread 5/8-24UNEF, 3 contacts
10SL-4	Thread 5/8-24UNEF, 2 contacts
12S-3	Thread 3/4-20UNEF, 2 contacts
14S-2	Thread 7/8-20UNEF, 4 contacts
14S-6	Thread 7/8-20UNEF, 6 contacts

All dimensions in mm.

Circular Connectors

Panel Mount Connector, Receptacle Style

- Male & female circular connectors intermateable with MIL-DTL-5015.
- Features screw holes for panel mounting.
- Gaskets provide panel mount sealing, and can be used either side of the flange (not shown).
- Mates with C90-3106F Straight Plug connectors shown on previous page.



CIRCULAR

MALE CONTACT

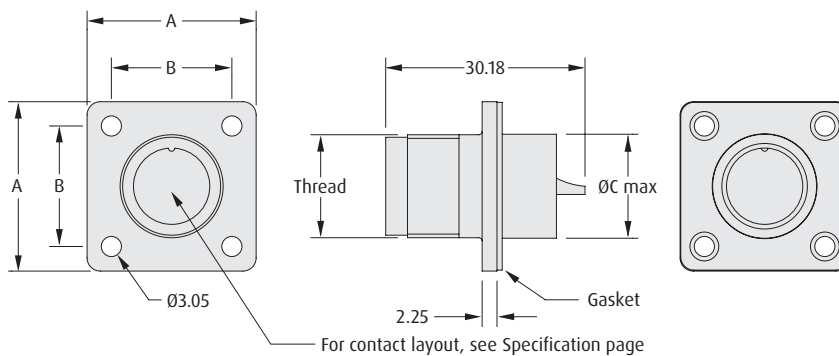

SHELL SIZE	THREAD	A	B	ØC
10SL-3	5/8-24UNEF	25.40	18.25	15.75
10SL-4	5/8-24UNEF	25.40	18.25	15.75
12S-3	3/4-20UNEF	28.02	20.62	17.17
14S-2	7/8-20UNEF	30.40	23.02	18.92
14S-6	7/8-20UNEF	30.40	23.02	18.92

FEMALE CONTACT

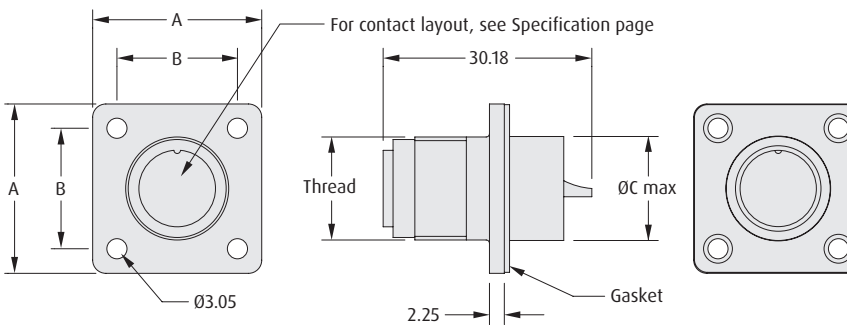

HOW TO ORDER

C90 - 3102R XXXX - X X

SERIES CODE

TYPE

3102R Panel mount connector with gasket

CONTACT GENDER

P	Male
S	Female

SHELL SIZE

10SL-3	Thread 5/8-24UNEF, 3 contacts
10SL-4	Thread 5/8-24UNEF, 2 contacts
12S-3	Thread 3/4-20UNEF, 2 contacts
14S-2	Thread 7/8-20UNEF, 4 contacts
14S-6	Thread 7/8-20UNEF, 6 contacts

All dimensions in mm.

Circular Connectors

CIRCULAR

Dust Caps & Rubber Bushing

- ❖ Dust cap with external thread for use with Straight Plugs (C90-3106F).
- ❖ Dust cap with internal thread for use with Cable connectors (C90-3101F) and Panel Mount connectors (C90-3102R).
- ❖ Dust caps supplied fitted with chain.
- ❖ Rubber Bushing for use with Cable connectors (C90-3101F).



DUST CAP – EXTERNAL THREAD

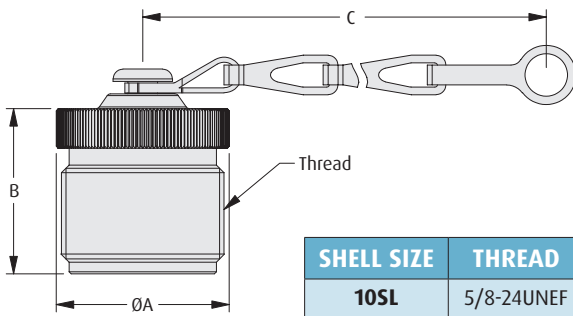

SHELL SIZE	THREAD	ØA max	B max	C
10SL	5/8-24UNEF	17.45	16.66	101.60
12S	3/4-20UNEF	20.62	21.44	114.30
14S	7/8-20UNEF	23.80	21.44	114.30

DUST CAP – INTERNAL THREAD

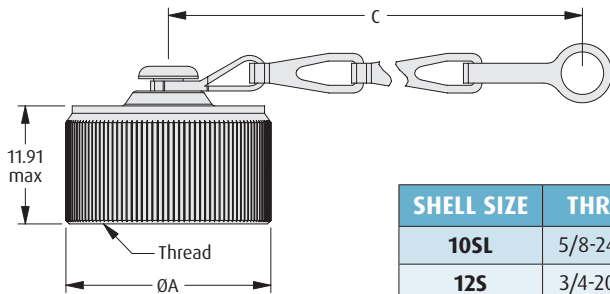

SHELL SIZE	THREAD	ØA max	C
10SL	5/8-24UNEF	20.70	101.60
12S	3/4-20UNEF	25.40	114.30
14S	7/8-20UNEF	28.57	114.30

RUBBER BUSHING

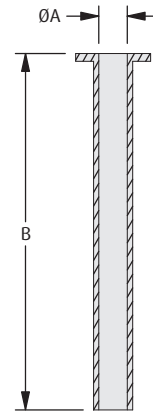

TYPE	ØA	B
4	5.59	69.85
6	7.92	66.68

HOW TO ORDER

C90 - 2504 X - XXXX

SERIES CODE

TYPE

2	External thread
3	Internal thread

SIZE

10SL	For 10SL shell size
12S	For 12SL shell size
14S	For 14SL shell size

HOW TO ORDER

C90 - 3420 - X

SERIES CODE

TYPE

4	For 10SL shell size
4	For 12SL shell size
6	For 14SL shell size

All dimensions in mm.