

Customer Information Sheet

DRAWING No.: M80-5T10222M3-02-332-00-000

SHEET 2 OF 2

IF IN DOUBT - ASK

©

NOT TO SCALE

THIRD ANGLE PROJECTION

ALL DIMENSIONS IN mm

SPECIFICATIONS:

MATERIAL:
 MOULDING: GLASS FILLED PPS, UL94V-0, BLACK
 SIGNAL CONTACT: PHOSPHOR BRONZE
 POWER CONTACT: COPPER ALLOY
 JACKSCREW: STAINLESS STEEL

FINISH:
 SIGNAL CONTACT:
 0.75µ GOLD ON CONTACT AREA,
 0.3µ 90/10 TIN/LEAD ON TAILS
 POWER CONTACT: GOLD

ELECTRICAL:
 WORKING VOLTAGE = 800V AC/DC
 VOLTAGE PROOF = 1200V AC/DC
 INSULATION RESISTANCE = 100MΩ MIN

SIGNAL CONTACT:
 CURRENT RATING AT 25°C = 3.0A MAX
 CURRENT RATING AT 85°C = 2.2A MAX
 CONTACT RESISTANCE = 25mΩ MAX
POWER CONTACT:
 CONTACT RESISTANCE 6mΩ MAX
 CURRENT RATING = 20A MAX

MECHANICAL:
 DURABILITY = 500 OPERATIONS
SIGNAL CONTACT:
 INSERTION FORCE = 2.0N MAX
 WITHDRAWAL FORCE = 0.2N MIN
POWER CONTACT:
 INSERTION FORCE = 8.0N MAX
 WITHDRAWAL FORCE = 0.5N MIN

ENVIRONMENTAL:
 TEMPERATURE RANGE = -55°C TO +125°C

PACKING:
 TUBE
 FOR COMPLETE SPECIFICATION SEE COMPONENT SPECIFICATION C005XX (LATEST ISSUE)

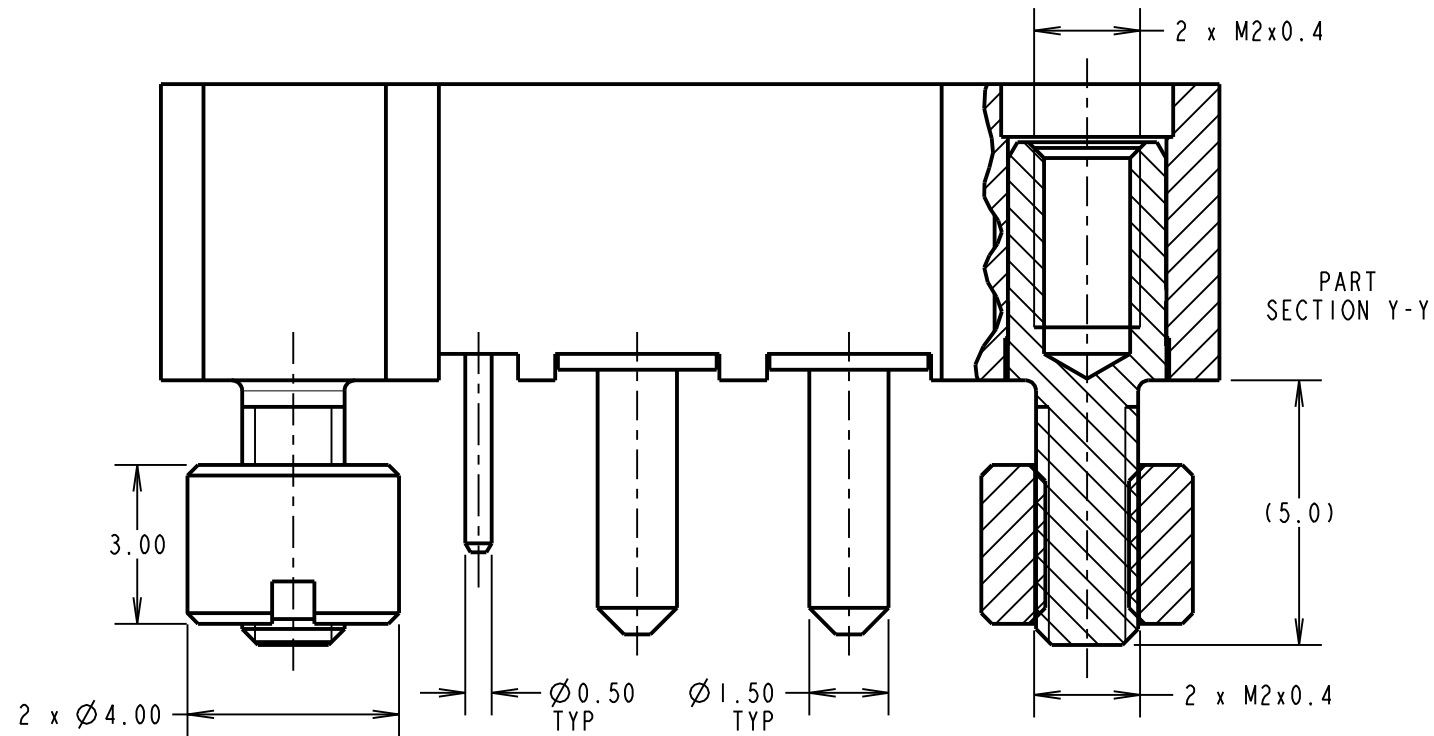
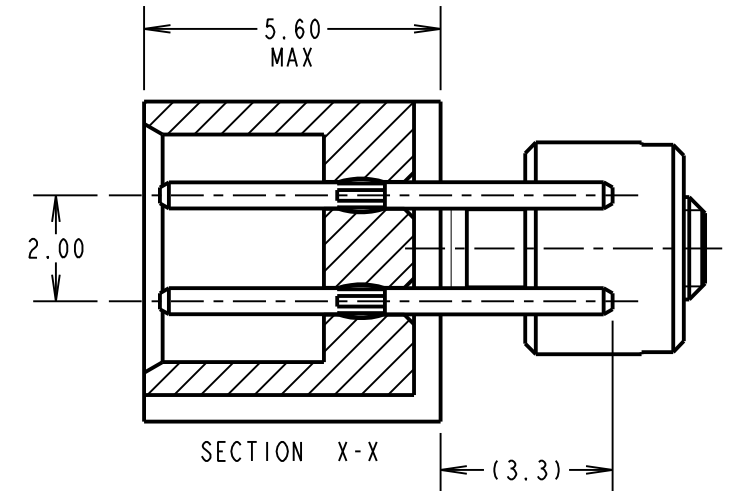
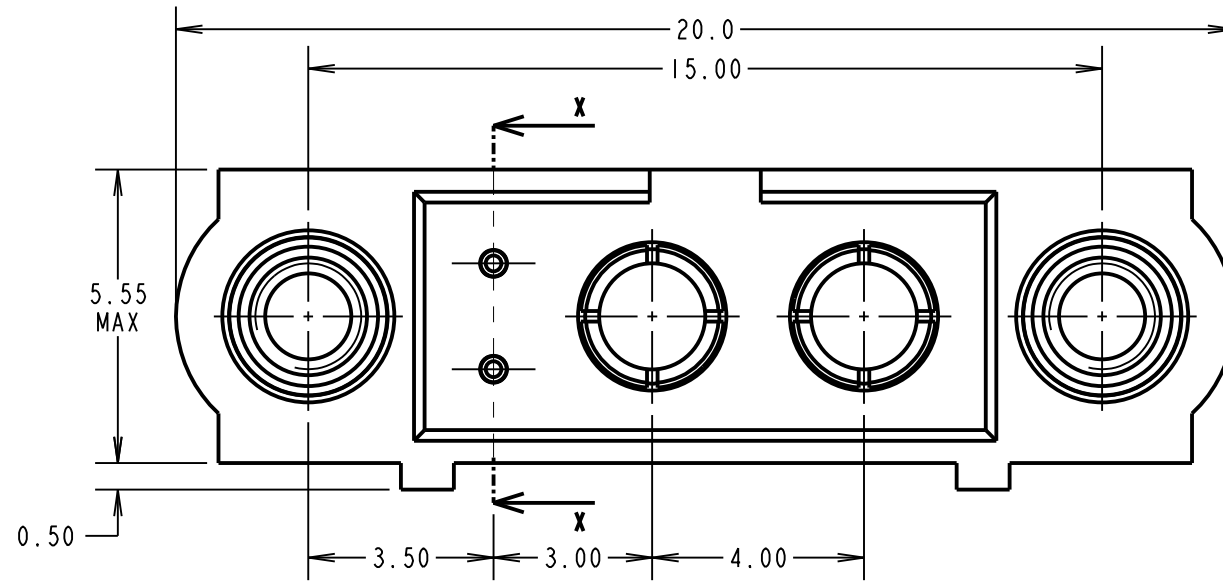

NOTE:
 1. CONNECTORS ARE SUPPLIED WITH NUTS LOOSE.

COMPLETE ASSEMBLY SHOWN FOR ILLUSTRATION ONLY

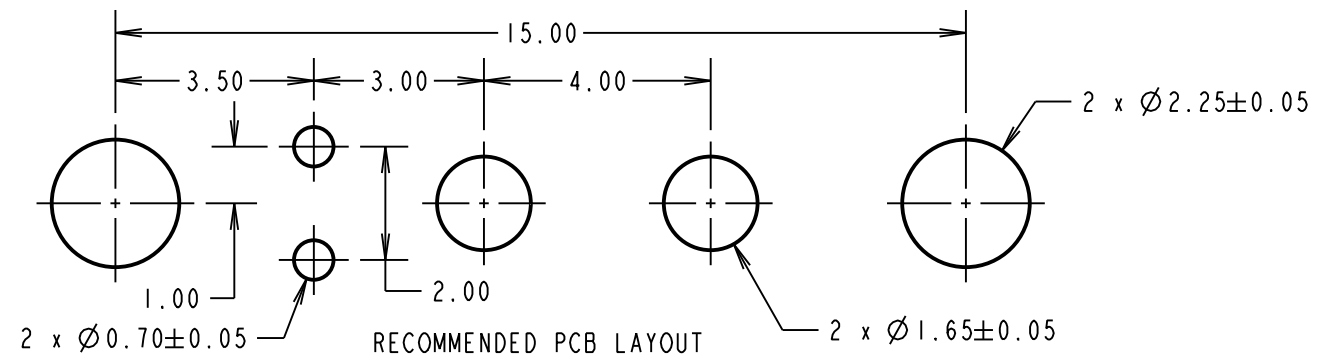
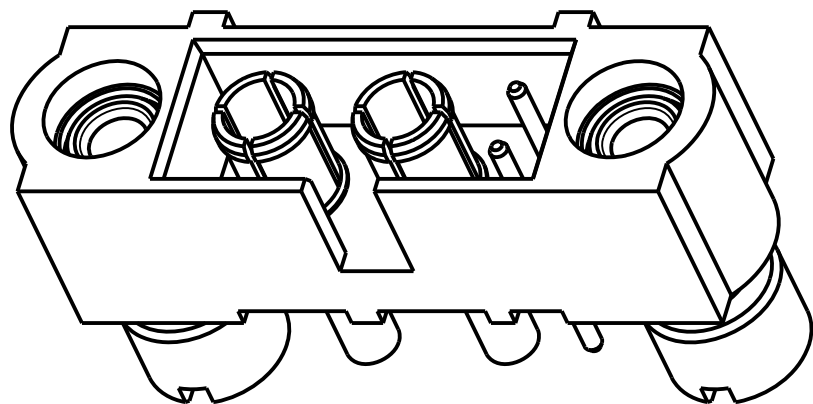

FM	2	06.10.17	13269
NAME	ISS.	DATE	C/NOTE
APPROVED: F. MCGOWAN			
CHECKED: M. PLESTED			
DRAWN: S. MCCULLAGH			
CUSTOMER REF.:			
ASSEMBLY DRG:			

HARWIN

www.harwin.com
 technical@harwin.com

THIS DRAWING AND ANY INFORMATION OR DESCRIPTIVE MATTER SET OUT HEREON ARE CONFIDENTIAL AND COPYRIGHT PROPERTY OF THE HARWIN GROUP AND MUST NOT BE DISCLOSED, LOANED, COPIED OR USED FOR MANUFACTURING, TENDERING OR FOR ANY OTHER PURPOSE WITHOUT THEIR WRITTEN PERMISSION.

TOLERANCES
 X. = ±1mm
 X.X = ±0.50mm
 X.XX = ±0.10mm
 X.XXX = ±0.01mm
 ANGLES = ±5°
 UNLESS STATED

MATERIAL:

SEE ABOVE

FINISH:

SEE ABOVE

S/AREA:

mm²

TITLE: JACKSCREW DATAMATE MIXED TECHNOLOGY PC TAIL MALE ASSEMBLY

DRAWING NUMBER:

M80-5T10222M3-02-332-00-000

SHT
 2 OF 2