

Customer Information Sheet

DRAWING No.: M80-4C1204200-04-305-00-000

SHEET 2 OF 2

IF IN DOUBT - ASK

©

NOT TO SCALE

THIRD ANGLE PROJECTION

ALL DIMENSIONS IN mm

SPECIFICATIONS:

MATERIAL:

MOULDING: GLASS FILLED PPS, UL94V-0, BLACK

SIGNAL CONTACT:

CLIP = BERYLLIUM COPPER
SHELL = COPPER ALLOY

COAX CONTACT:

BODY, SLEEVE = COPPER ALLOY
INNER CONTACT, LATCHING COLLAR = BERYLLIUM COPPER
INSULATOR = PTFE

FINISH:

SIGNAL CONTACT:

CLIP = 0.3µ GOLD
SHELL = 3.5-5.0µ 100% TIN OVER NICKEL

COAX CONTACT:

BODY, SLEEVE, INNER CONTACT = GOLD
LATCHING COLLAR = NICKEL

ELECTRICAL:

WORKING VOLTAGE = 120V AC/DC

VOLTAGE PROOF = 360V AC/DC

INSULATION RESISTANCE = 100MΩ MIN

SIGNAL CONTACT:

CURRENT RATING AT 25°C = 3.0A MAX

CURRENT RATING AT 85°C = 2.2A MAX

CONTACT RESISTANCE = 25 mΩ MAX

COAX CONTACT:

FREQUENCY RANGE = 6GHz

IMPEDANCE = 50 Ω

V.S.W.R = 1.05 + (0.04 x FREQUENCY) GHz MAX

CONTACT RESISTANCE 6 mΩ MAX

INSULATION RESISTANCE = 10⁶MΩ @250V AC

OPERATING VOLTAGE = 180V AC @ 500mA

MAXIMUM VOLTAGE = 1000V AC

MECHANICAL:

DURABILITY = 500 OPERATIONS

SIGNAL CONTACT:

INSERTION FORCE = 2.8N MAX

WITHDRAWAL FORCE = 0.2N MIN

COAX CONTACT:

INSERTION FORCE = 5N MAX

WITHDRAWAL FORCE = 0.5N MIN

ENVIRONMENTAL:

TEMPERATURE RANGE = -55°C TO +125°C

PACKING:

BAG

FOR COMPLETE SPECIFICATION SEE COMPONENT SPECIFICATION C005XX (LATEST ISSUE)

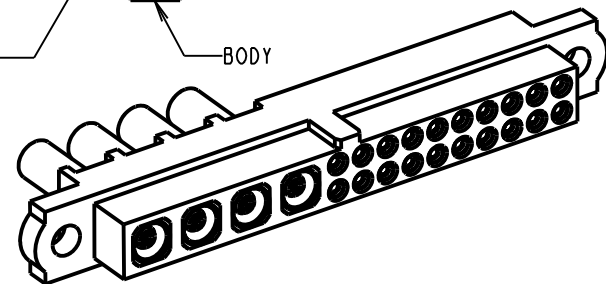
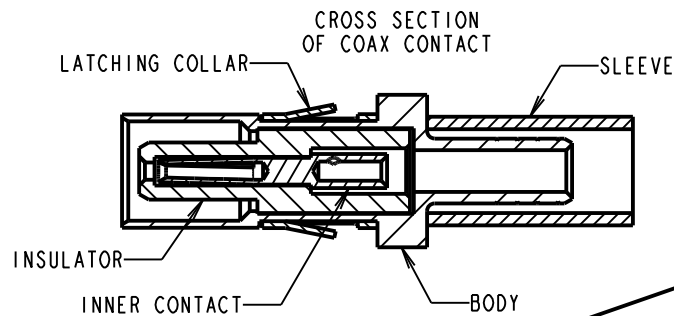
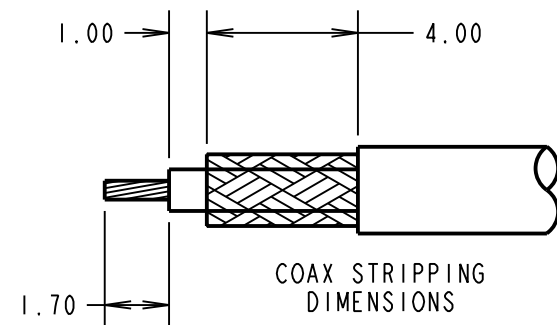
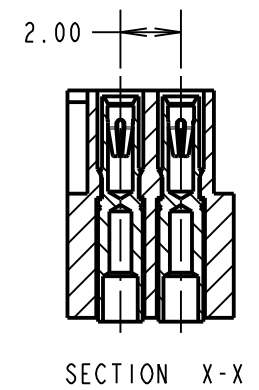
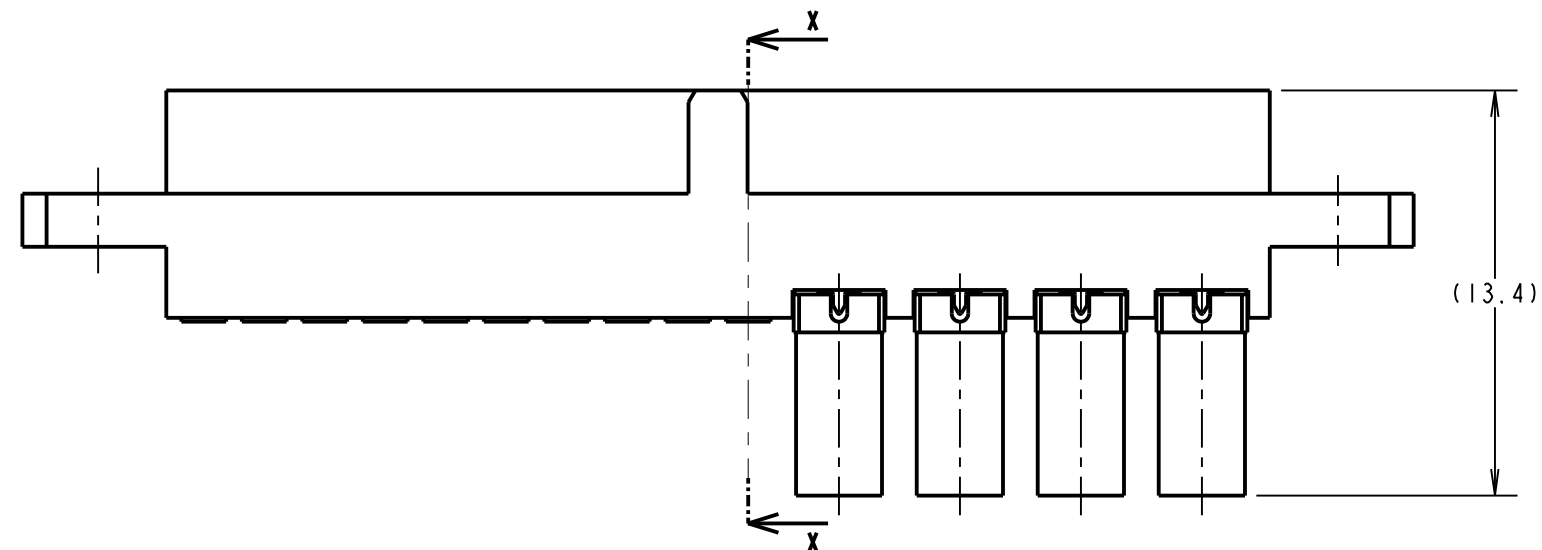
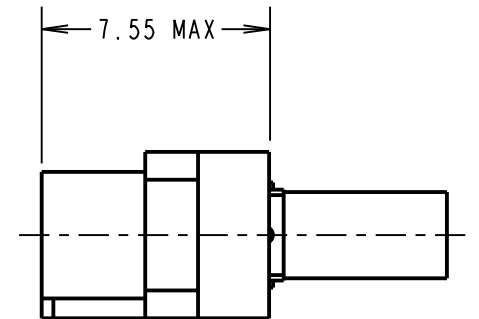
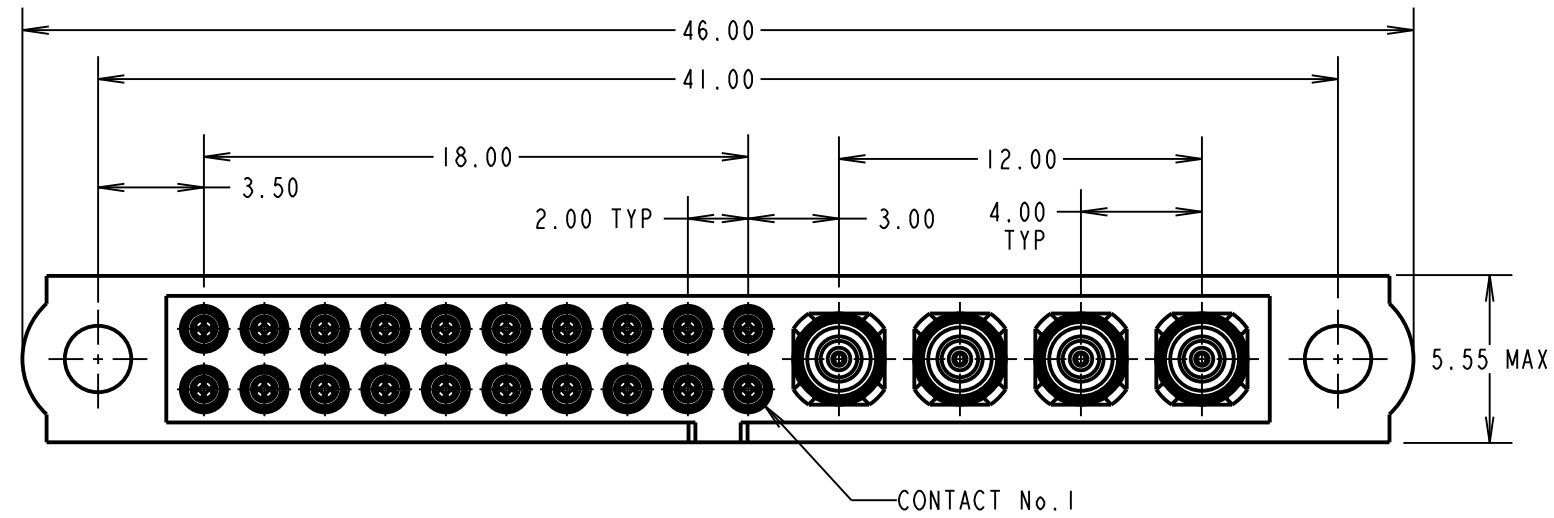

NOTES:

- CONNECTORS ARE SUPPLIED WITH CONTACTS LOOSE.
- FOR EXTRA SIGNAL CONTACTS, USE PART NUMBER M80-0130001.
- RECOMMENDED SIGNAL WIRE TYPE = BS 3G 210 TYPE A, PTFE INSULATED 24-28 AWG. MAX INSULATION DIAMETER = Ø1.10mm. STRIP WIRE BY 2.00MM FOR CRIMPING.
- RECOMMENDED HAND CRIMP TOOL FOR SIGNAL CONTACTS = M22520/2-01 WITH POSITIONER T5747.
- SIGNAL CONTACT INSERTION AND EXTRACTION TOOL = Z80-280.
- COAX CONTACT IS SUPPLIED AS A KIT OF PARTS: BODY, INSULATOR AND LATCHING COLLAR ARE PRE-ASSEMBLED AND SLEEVE AND INNER CONTACT ARE SEPARATE.
- FOR EXTRA COAX CONTACTS, USE PART NUMBER M80-305.
- RECOMMENDED HAND CRIMP TOOL FOR COAX INNER CONTACT = Z80-292 WITH POSITIONER Z80-291 AND RECOMMENDED HAND CRIMP TOOL AND DIE SET FOR COAX SLEEVE = Z80-293.
- COAX CONTACT EXTRACTION TOOL = Z80-290
- INSTRUCTION SHEETS ARE AVAILABLE.

SM	I	05.04.11	-----
NAME	ISS.	DATE	C/NOTE
APPROVED:		S. MCCULLAGH	
CHECKED:		M. G. PLESTED	
DRAWN:		S. MCCULLAGH	
CUSTOMER REF.:			
ASSEMBLY DRG:			

HARWIN

HARWIN USA
TEL: 603 893 5376
FAX: 603 893 5396
mis@harwin.com

HARWIN Europe (UK)
TEL: 023 9231 4545
FAX: 023 9231 4590
mis@harwin.co.uk

HARWIN Asia
TEL: +65 6 779 4909
FAX: +65 6 779 3868
mis@harwin.com.sg

THIS DRAWING AND ANY INFORMATION OR DESCRIPTIVE MATTER SET OUT HEREON ARE CONFIDENTIAL AND COPYRIGHT PROPERTY OF THE HARWIN GROUP AND MUST NOT BE DISCLOSED, LOANED, COPIED OR USED FOR MANUFACTURING, TENDERING OR FOR ANY OTHER PURPOSE WITHOUT THEIR WRITTEN PERMISSION.

TOLERANCES
X. = ±1mm
X.X = ±0.25mm
X.XX = ±0.10mm
X.XXX = ±0.01mm
ANGLES = ±5°
UNLESS STATED

MATERIAL:

SEE ABOVE

FINISH: SEE ABOVE

S/AREA:

mm²

TITLE: JACKSCREW DATAMATE
MIXED TECHNOLOGY
CRIMP FEMALE ASSEMBLY

DRAWING NUMBER:

M80-4C1204200-04-305-00-000

SHT
2 OF 2