

M80-4211601

Datamate J-Tek DIL Female Vertical PC Tail Connector, 2mm Pitch

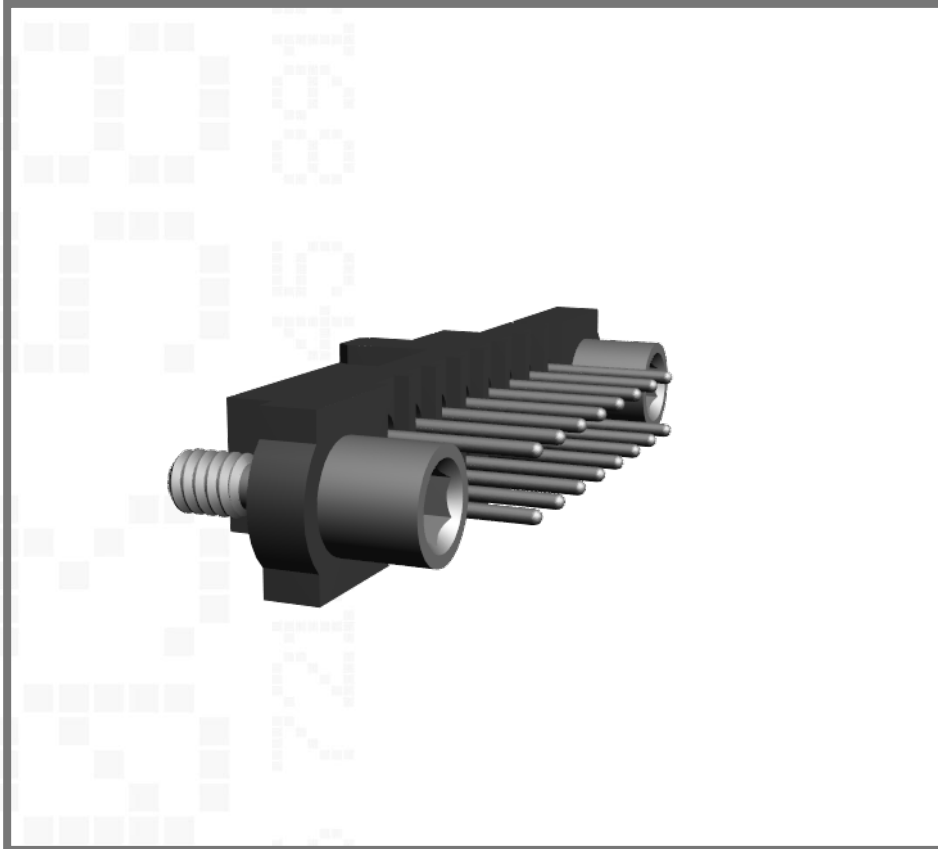

Technical Drawing:

[M80-421.pdf](#)

Website:

[M80-4211601](#)

Component Specification:

[C005XX](#)

[Request an evaluation sample](#)

4.5mm Tail, Hexagonal Socket Jackscrews, Gold Clip + Tin/Lead Shell, 8+8 contacts