

M80-4050842

Datamate J-Tek DIL Female Vertical PC Tail Connector, 2mm Pitch

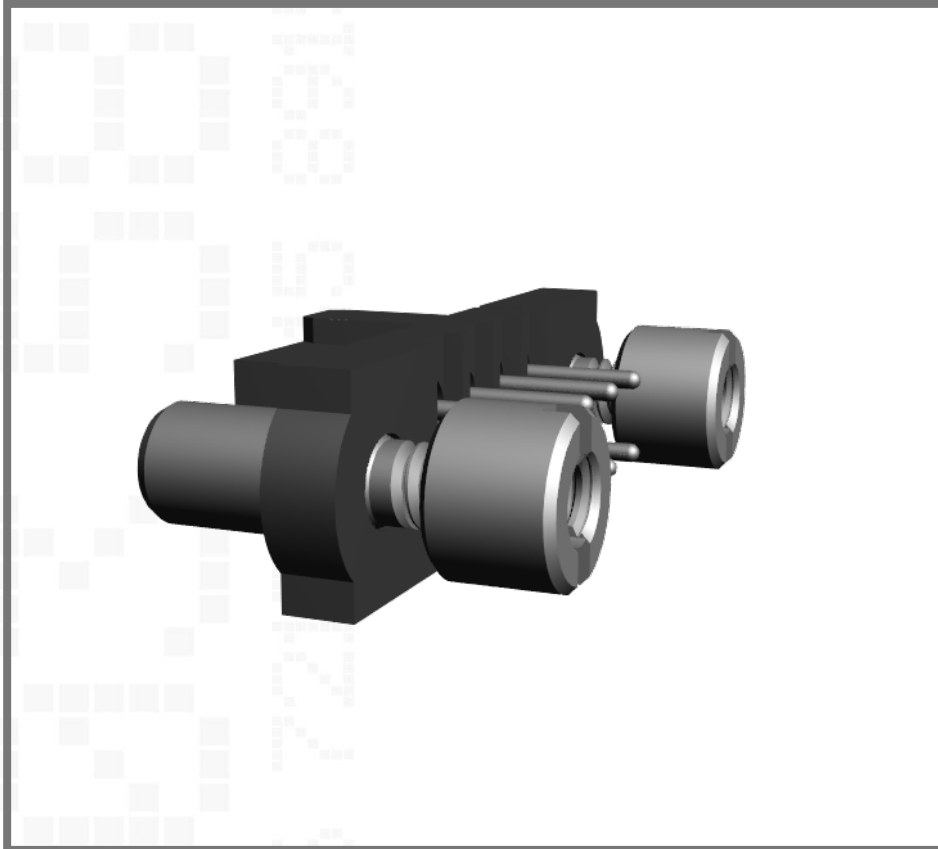

Technical Drawing:

[M80-405.pdf](#)

Website:

[M80-4050842](#)

Component Specification:

[C005XX](#)

[Request an evaluation sample](#)

3mm Tail, Reverse Fix Jackscrews, Gold Clip + Tin Shell, 4+4 contacts