

M80-4001042

Datamate J-Tek DIL Female Vertical PC Tail Connector, 2mm Pitch

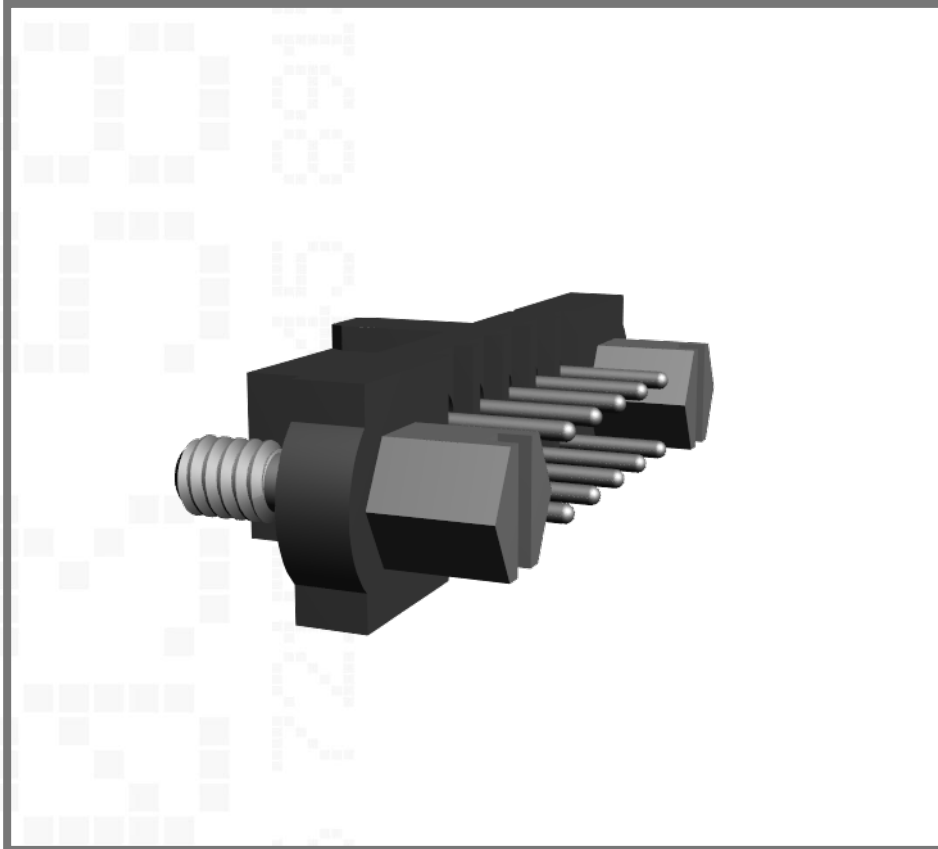

Technical Drawing:

[M80-400.pdf](#)

Website:

[M80-4001042](#)

Component Specification:

[C005XX](#)

[Request an evaluation sample](#)

3mm Tail, Hexagonal Slotted Jackscrews, Gold Clip + Tin Shell, 5+5 contacts