

HARWIN

Datamate J-Tek – Extended Height



Datamate High-Reliability Connectors

INDUSTRY RECOGNISED, PROVEN PERFORMANCE



Datamate is the field-proven high-reliability range of choice for many industries.

- Complies with British Standard 9525-F0033 (1 & 2-row) and CECC 75101-008 (1, 2 & 3-row);
- Designed with aerospace, military and other "high-end" applications in mind;
- Proven in many years of successful service;
- Successfully and internationally utilised in COTS programs.

Datamate J-Tek Extended Height

INCREASED COMPONENT HEIGHT

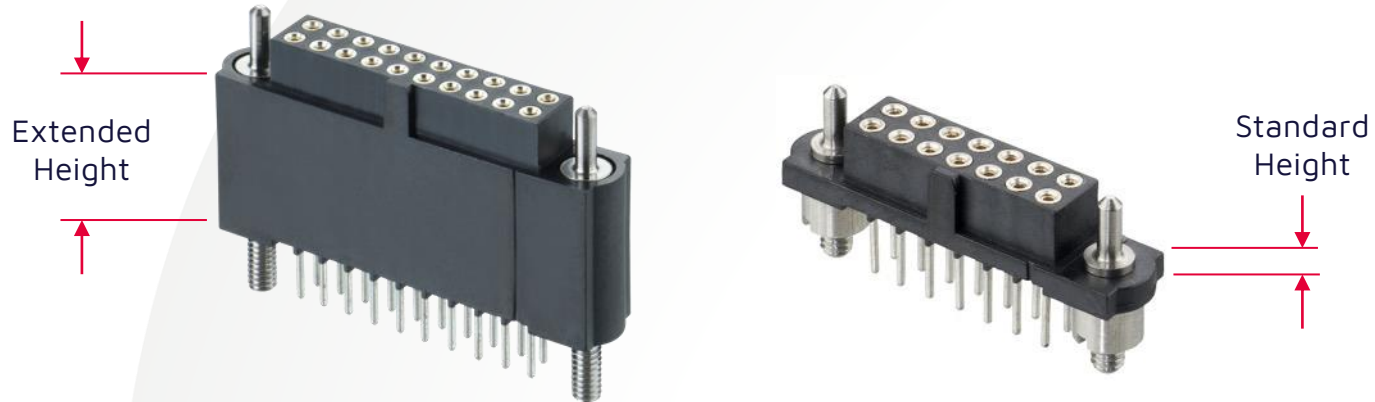

The Datamate board mounted connectors were designed to be as small as possible, with no wasted space. For board-to-board, this meant the spacing between parallel PCBs was also small – sometimes restricting the size of the other components used on these boards.

Components like relays and capacitors are often taller than the Datamate connectors, so a revised design with added height was needed for these applications.

Datamate J-Tek Extended Height

HIGHER BOARD STACK HEIGHT

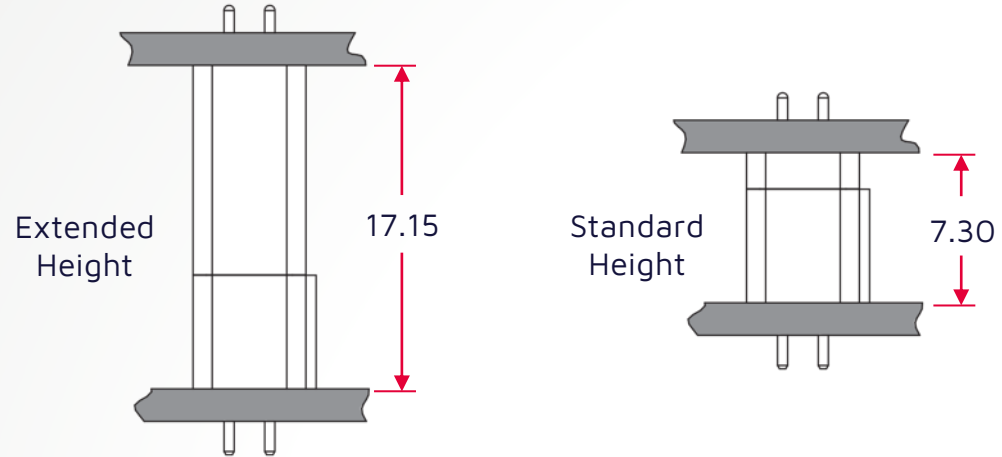

The extra height on the female connector gives a board-to-board stacking height of 17.15mm when mated with the male vertical throughboard connector – an increase of nearly 10mm.

This allows more room between PCBs for board components taller than 7.3mm, or for cables to be routed or terminated on the inside faces of these boards.

Datamate J-Tek Extended Height

GUIDE PINS AND BOARD MOUNT

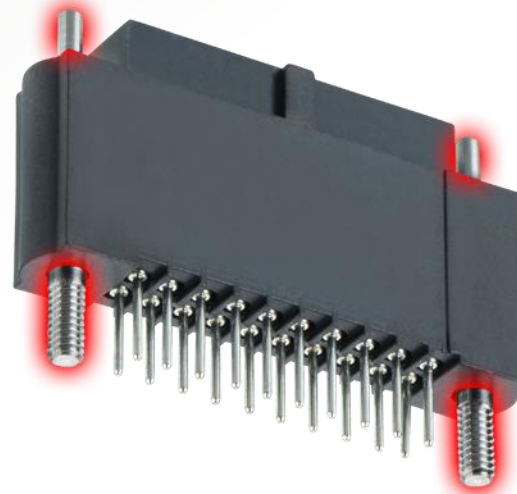

Stainless steel guide pins help with the board-to-board mating – they fit into any male internal threaded jackscrew.

Under the connector, 5mm long threaded studs (combined with nuts available separately) provide strain relief for the soldered terminations. Tighten the nuts to 22cmN torque for resistance long-term against vibration and shock.

The terminations are 4.4mm long, use in any board thickness up to 3.2mm.

Datamate J-Tek Extended Height

FEATURES – SHROUDED, POLARIZED, NO. 1 CONTACT

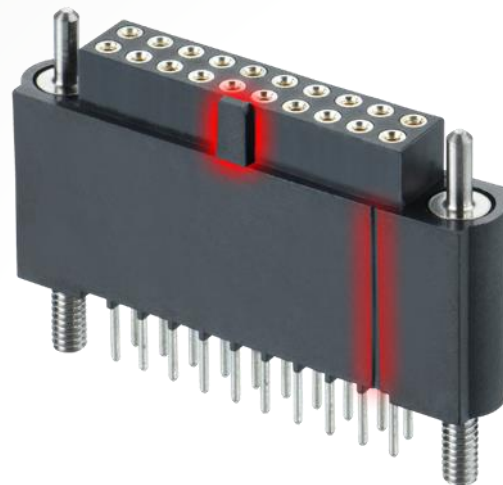

All the extended height Datamate J-Tek female connectors have individually shrouded socket contacts and a easy-to-see side polarizing feature. These features are identical to the standard height connectors, and are compatible with the male connectors in the J-Tek family.

The housings also have an ident stripe built in, to identify contact number 1. Check the [CO05 Component Specification](#) for the full numbering system.

Datamate J-Tek Extended Height

AVAILABLE PRODUCT RANGE



10 contacts (5+5)

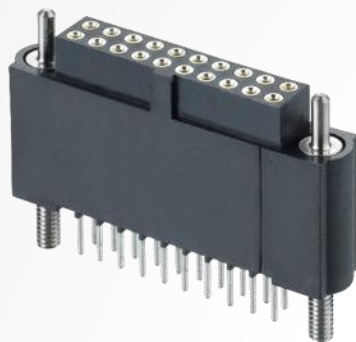

20 contacts (10+10)

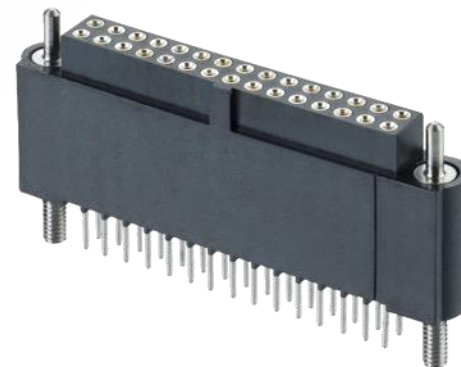

30 contacts (15+15)

Currently there are 3 contact count options for female extended height connectors in the Datamate J-Tek range.

Gold on contact area, Tin on terminations:

- [M80-4TE1042F3](#) – 10 contacts (5+5)
- [M80-4TE2042F3](#) – 20 contacts (10+10)
- [M80-4TE3042F3](#) – 30 contacts (15+15)

Gold on contact area and terminations:

- [M80-4TE1005F3](#) – 10 contacts (5+5)
- [M80-4TE2005F3](#) – 20 contacts (10+10)
- [M80-4TE3005F3](#) – 30 contacts (15+15)

Datamate J-Tek Extended Height

COMPATIBLE MALE CONNECTORS

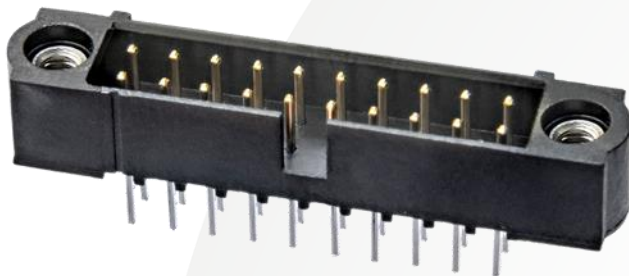

Throughboard

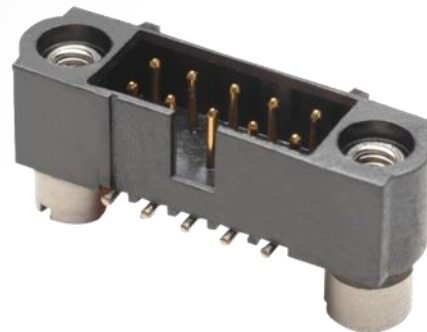

Surface Mount

The extended female connectors are compatible with any of the male vertical PCB connectors in the J-Tek family, including:

Male Throughboard (for 17.15mm stack height):

- [M80-500 series](#) – internal jackscrew, 3mm termination
- [M80-510 series](#) – board mount jackscrew, 3mm termination
- [M80-511 series](#) – board mount jackscrew, 4.5mm termination

Male SMT (for 17.4mm stack height):

- [M80-502 series](#) – internal jackscrew
- [M80-512 series](#) – 3.5mm board mount jackscrew
- [M80-513 series](#) – 5mm board mount jackscrew

Datamate J-Tek Extended Height

ACCESSORIES



Slotted



Hexagonal

The extended height connectors are not supplied with the board mount nuts for termination strain relief – these will need to be ordered separately:

- [M80-2130000B](#) – Slotted M2 board mount nut
- [M80-2430000B](#) – Hexagonal M2 board mount nut



Datamate J-Tek Extended Height

ELECTRICAL SPECIFICATION HIGHLIGHTS

Current Rating	3.3A max (single contact) 3.0A max (all contacts)
Working Voltage	800V DC or AC _{peak}
Voltage Proof (Maximum Voltage)	1,200V DC or AC _{peak}

The Datamate range is a professional connector system aimed at Commercial or COTS prices. It is field-proven in tough terrains and environments, from underground to outer space. The current rating exceeds the levels normally expected from a 2mm pitch connector system.

The full [Datamate Component Specification](#) is available to download from the Harwin website.



Datamate J-Tek Extended Height

MECHANICAL & ENVIRONMENTAL SPECIFICATION HIGHLIGHTS

Vibration	10g for 6 hours
Shock	100g
Durability	500 mating cycles
Temperature Range	-55°C to +125°C

The above specifications secure the reputation of the Datamate range as a High-Reliability connector. Multiple [Test Reports](#) for Datamate are available from the Technical Resource area at Harwin.com.

Datamate J-Tek Extended Height

MARKETS



Rugged, high-reliability connectors continue to be in strong demand in many varied environments. Small enough to be used in handheld and portable applications, yet high-powered enough to meet the demands of large-scale equipment, Datamate continues to find new applications and new product uses in existing and new customers.

- Aerospace
- Autosport
- Military
- Robotics
- Oil & Gas

Learn more about our other ranges



HIGH RELIABILITY
WITH SUPREME
PERFORMANCE



INNOVATIVE
DESIGNS FOR
EASY ASSEMBLY



DEPENDABLE
CONNECTIVITY
ACROSS THE BOARD

Find out more about our full range
of inter-connection solutions at
www.harwin.com

HRi
RANGE

EZi
RANGE

BBi
RANGE

Get Help from a Harwin Expert

Our experts are specialists in their field with many years of experience in their respective roles and industries.

Find an expert that can help you with your enquiry.

[Click Here >>](#)

CAD Models and Evaluation Samples also available at www.harwin.com



Contact Us.

Europe, Middle East & Africa

T: +44 (0)23 9231 4545

E: technical@harwin.com

Americas

T: +1 603 893 5376

E: technical-us@harwin.com

Asia Pacific

T: +65 6 779 4909

E: technical@harwinasia.com

www.harwin.com